

**INSTRUMENT
APPROACH
CHART - ICAO**

AERODROME ELEV 59 ft
HEIGHTS RELATED TO
THR RWY 14L - ELEV 38 ft

SEOUL APP 119.75
119.1
GIMPO TWR 118.1
118.05

**SEOUL/Gimpo Intl(RKSS)
ILS Z or LOC Z RWY 14L**

Note : Approach under ICAO Flight Procedures.

126°40' E

126°50' E

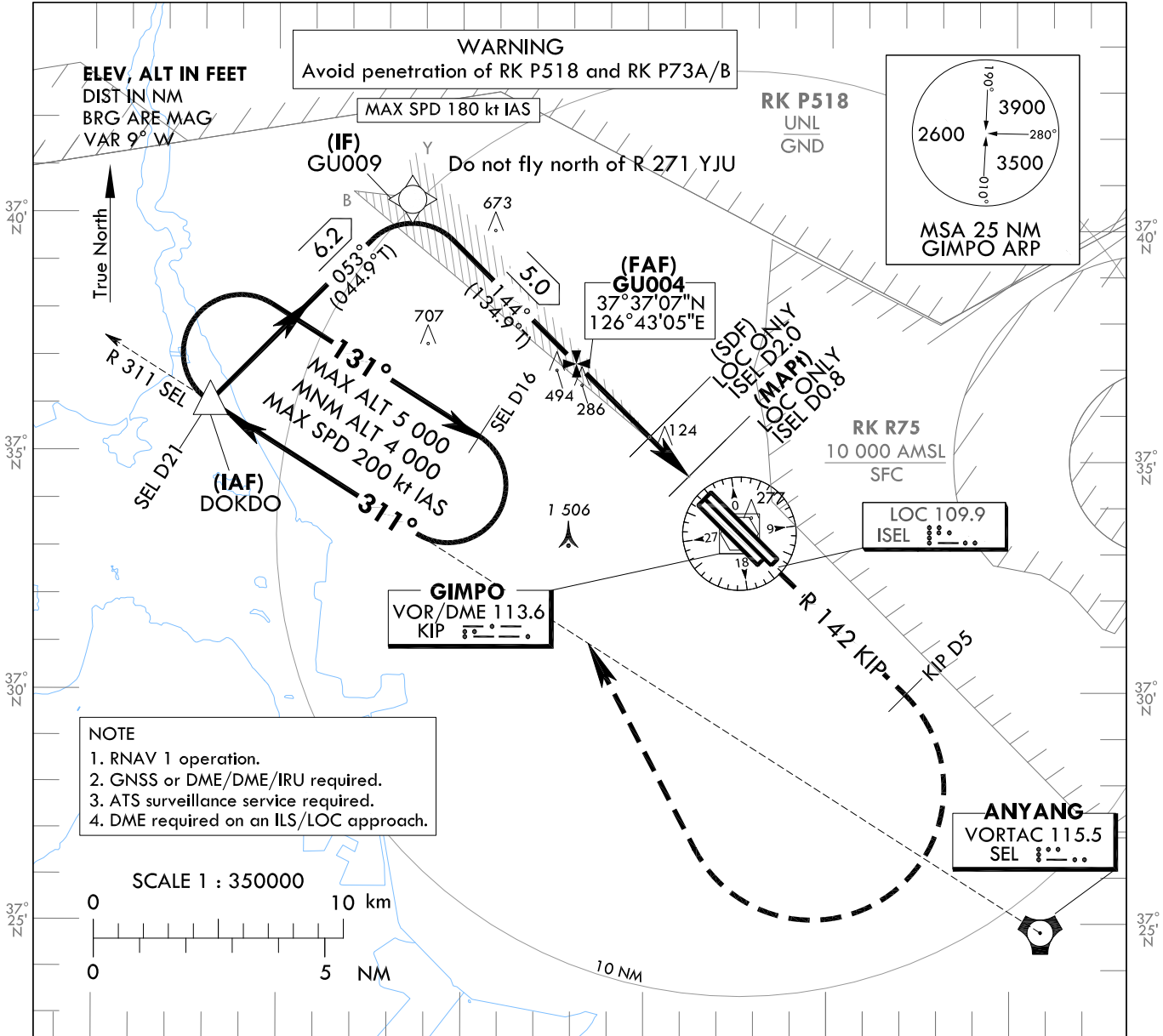

- NOTE**
1. RNAV 1 operation.
 2. GNSS or DME/DME/IRU required.
 3. ATS surveillance service required.
 4. DME required on an ILS/LOC approach.

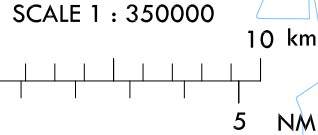

RECOMMENDED PROFILE	DME ISEL	4	3	2
Final Approach Gradient 5.24%, 318 ft/NM	ALT(HGT)	1 336 (1 298)	1 018 (980)	700 (662)

TRANSITION ALT 14 000
TRANSITION LVL FL 140

- NOTE**
1. Missed approach turn limited to 220 kt IAS maximum.

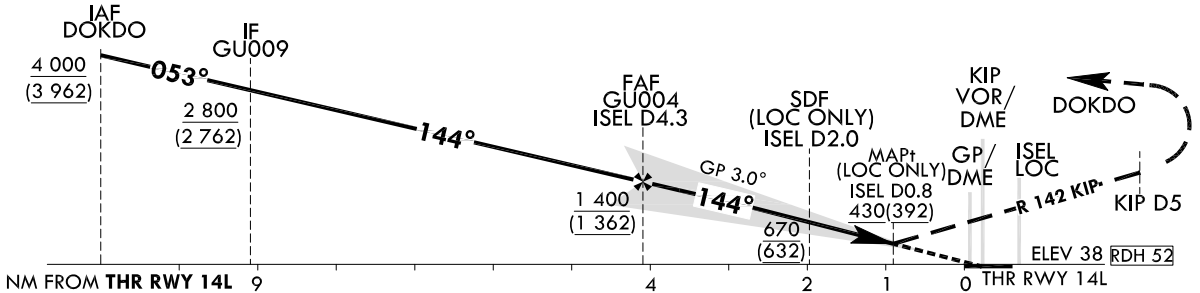

CATEGORY	DA(DH)/MDA(MDH)	A	B	C	D	MISSED APPROACH Climb to 4 000 ft on RWY HDG to R 142 KIP/D5 then turn right to intercept and proceed via R 311 SEL to DOKDO. Hold as published.
Straight-in	CAT-I	238 (200)	RVR 550 m, VIS 800 m			* Timing Not authorized for defining MAPt. * Circling Not authorized.
		430 (392)	1 200 m	1 100 m	1 800 m	
	LOC	430 (392)	1 200 m	1 100 m	1 800 m	
		430 (392)	1 200 m	1 100 m	1 800 m	

Change : Amended phrase for LOC category.

SEOUL/Gimpo Intl(RKSS)
ILS Z or LOC Z RWY 14L

AERONAUTICAL DATA TABULATION

ILS/LOC Z Approach to RWY 14L from DOKDO		
Fix / Point		Coordinates
DOKDO(IAF)		37°36'17.1"N 126°33'07.1"E
GU009(IF)	BRG 53.48°/6.20 NM	37°40'40.0"N 126°38'36.6"E
GU004(FAF)	BRG 143.54°/4.30 NM ISEL	37°37'07.1"N 126°43'04.8"E
D2.0 ISEL (SDF LOC ONLY)	BRG 143.54°/2.00 NM ISEL	37°35'32.2"N 126°45'04.3"E
D0.8 ISEL (MAPt LOC ONLY)	BRG 143.54°/0.80 NM ISEL	37°34'41.1"N 126°46'08.4"E
THR RWY 14L		37°34'14.55"N 126°46'41.80"E
ISEL DME		37°34'03.8"N 126°46'48.1"E
KIP VOR/DME		37°33'27.1"N 126°47'31.3"E
D5 KIP	R 142 KIP/5.00 NM	37°29'58.1"N 126°52'02.1"E
DOKDO	R 311 SEL/21.00 NM	37°36'17.1"N 126°33'07.1"E

**INSTRUMENT
APPROACH
CHART - ICAO**

AERODROME ELEV 59 ft
HEIGHTS RELATED TO
THR RWY 14L - ELEV 38 ft

SEOUL APP 119.75
119.1
GIMPO TWR 118.1
118.05

**SEOUL/Gimpo Intl(RKSS)
ILS Y or LOC Y RWY 14L**

Note : Approach under ICAO Flight Procedures. 126°40'E 26°50'E

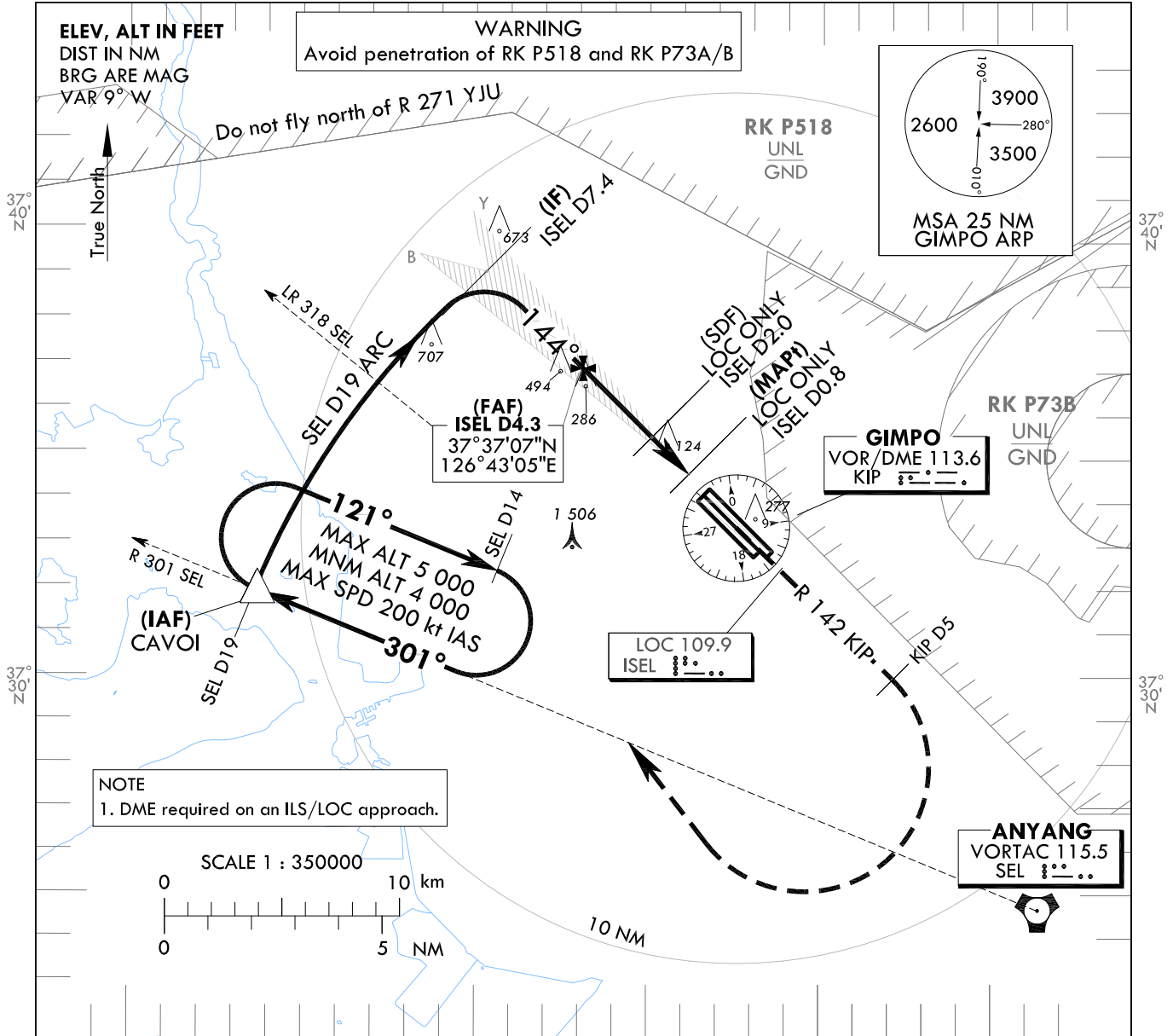

RECOMMENDED PROFILE		DME ISEL	4	3	2
Final Approach Gradient 5.24%, 318 ft/NM		ALT(HGT)	1 336 (1 298)	1 018 (980)	700 (662)

TRANSITION ALT 14 000
TRANSITION LVL FL 140

NOTE
1. Missed approach turn limited to 220 kt IAS maximum.

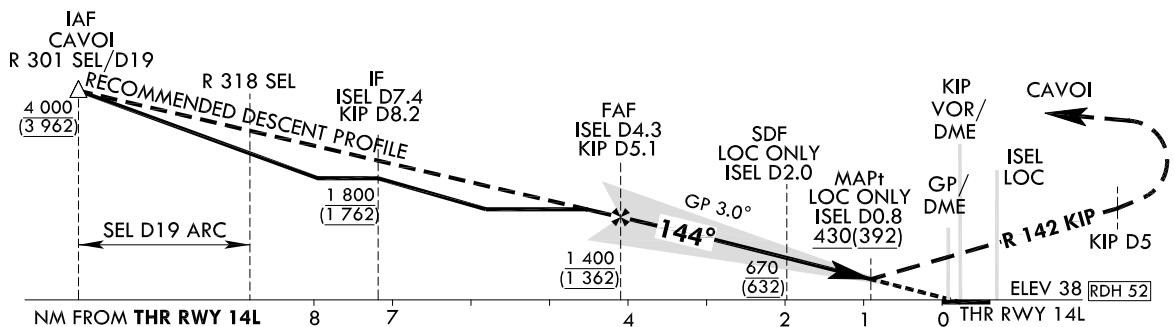

CATEGORY	DA(DH)/MDA(MDH)	A B C D				MISSED APPROACH Climb to 4 000 ft on RWY HDG to R 142 KIP /D5 then turn right to intercept and proceed via R 301 SEL to CAVOI. Hold as published. * Timing Not authorized for defining MAPt. * Circling Not authorized.
		RVR 550 m, VIS 800 m				
Straight-in	CAT-I	FULL	RVR 550 m, VIS 800 m			
		ALS INOP	1 200 m			
	LOC	FULL	1 100 m			
		ALS INOP	1 800 m			

SEOUL/Gimpo Intl(RKSS)
ILS Y or LOC Y RWY 14L

AERONAUTICAL DATA TABULATION

ILS/LOC Y Approach to RWY 14L from CAVOI			
Fix / Point		Coordinates	
CAVOI(IAF)	R 301 SEL/19.00 NM SEL	37°32'02.0"N	126°33'37.0"E
D7.4 ISEL(IF)	BRG 143.54°/7.40 NM ISEL	37°39'20.6"N	126°40'16.7"E
D4.3 ISEL(FAF)	BRG 143.54°/4.30 NM ISEL	37°37'07.1"N	126°43'04.8"E
D2.0 ISEL (SDF LOC ONLY)	BRG 143.54°/2.00 NM ISEL	37°35'32.2"N	126°45'04.3"E
D0.8 ISEL (MAPt LOC ONLY)	BRG 143.54°/0.80 NM ISEL	37°34'41.1"N	126°46'08.4"E
THR RWY 14L		37°34'14.55"N	126°46'41.80"E
ISEL DME		37°34'03.8"N	126°46'48.1"E
KIP VOR/DME		37°33'27.1"N	126°47'31.3"E
D5 KIP	R 142 KIP/5.00 NM	37°29'58.1"N	126°52'02.1"E
CAVOI	R 301 SEL/19.00 NM	37°32'02.0"N	126°33'37.0"E

Change : Amended phrase(CAVOI(IAF) and D7.4 ISEL(IF)).

**INSTRUMENT
APPROACH
CHART - ICAO**

AERODROME ELEV 59 ft
HEIGHTS RELATED TO
THR RWY 14L - ELEV 38 ft

SEOUL APP 119.75
119.1
GIMPO TWR 118.1
118.05

**SEOUL/Gimpo Intl(RKSS)
RNP RWY 14L**

Note : Approach under ICAO Flight Procedures.

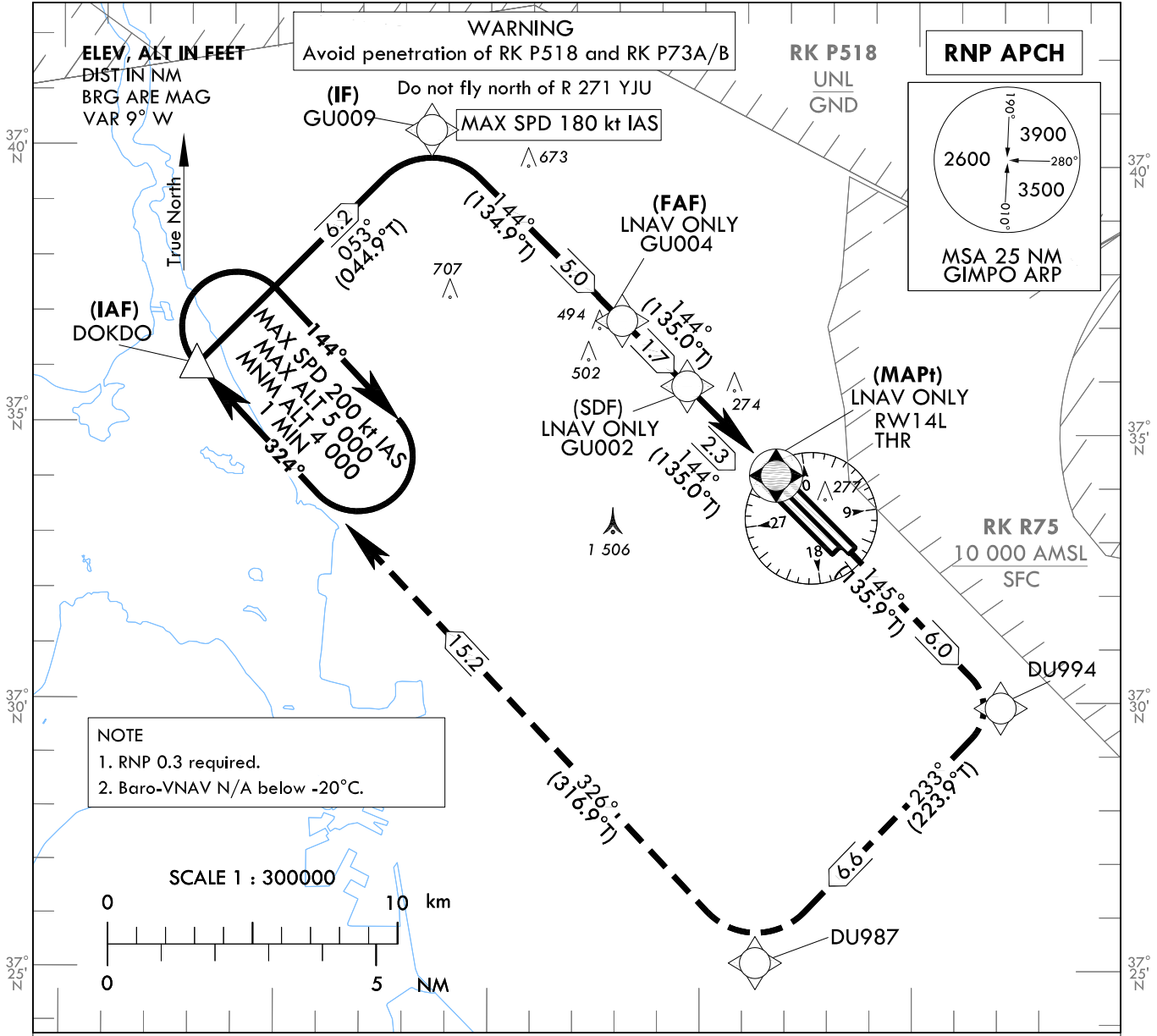

NOTE
1. RNP 0.3 required.
2. Baro-VNAV N/A below -20°C.

TRANSITION ALT 14 000
TRANSITION LVL FL 140

MISSED APPROACH
Climb to 4 000 ft. Track to DU994, DU987 and DOKDO. Hold as published.

NOTE
1. Missed approach turn limited to 220 kt IAS maximum.

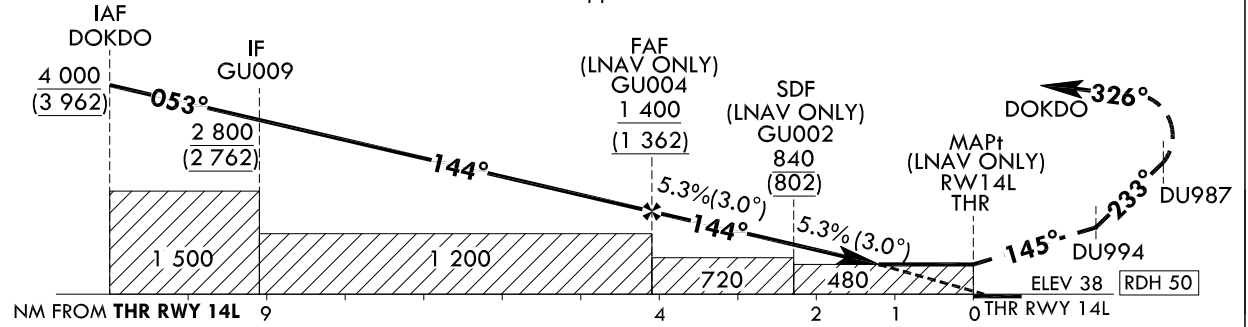

CATEGORY		MDA(H)/DA(H)	A	B	C	D	Knots						
LNAV	FULL	480 (442)		1 400 m			Rate of descent	V/V fpm	318	478	637	796	955
	ALS INOP			2 100 m									
LNAV/VNAV	FULL	450 (412)		1 200 m			* Timing Not authorized for defining MAPt. * Circling Not authorized.						
	ALS INOP			1 900 m									

Change : Page control.

AERONAUTICAL DATA TABULATION

Instrument Approach Procedure Coding Tables

RNP RWY 14L

Serial Number	Path Descriptor	Waypoint Identifier	Fly-over	Course/Track °M(°T)	Distance (NM)	Turn direction	Altitude (ft)	Speed (kt)	Coordinates	VPA/TCH	Navigation specification	Remarks
001	IF	DOKDO	-	-	-	-	+4 000	-	37°36'17.1"N 126°33'07.1"E	-	RNP APCH	IAF
002	TF	GU009	-	053 (044.9)	6.2	-	+2 800	-180	37°40'40.0"N 126°38'36.6"E	-	RNP APCH	IF
003	TF	GU004	-	144 (134.9)	5.0	-	+1 400	-	37°37'07.1"N 126°43'04.8"E	-	RNP APCH	FAF
004	TF	GU002	-	144 (135.0)	1.7	-	+840	-	37°35'54.2"N 126°44'36.6"E	-	RNP APCH	SDF
005	TF	RW14L	Y	144 (135.0)	2.3	-	+480	-	37°34'14.55"N 126°46'41.80"E	-3.01/50	RNP APCH	MAPt
006	TF	DU994	-	145 (135.9)	6.0	-	-	-	37°29'54.5"N 126°51'57.6"E	-	RNP APCH	-
007	TF	DU987	-	233 (223.9)	6.6	-	-	-220	37°25'09.3"N 126°46'13.6"E	-	RNP APCH	-
008	TF	DOKDO	Y	326 (316.9)	15.2	-	+4 000	-220	37°36'17.1"N 126°33'07.1"E	-	RNP APCH	-
009	HIM	DOKDO	Y	324 (314.9)	-	R	-5 000 +4 000	-200	37°36'17.1"N 126°33'07.1"E	-	RNP APCH	¹ min (Outbound timing)

**INSTRUMENT
APPROACH
CHART - ICAO**

AERODROME ELEV 59 ft
HEIGHTS RELATED TO
THR RWY 14R - ELEV 34 ft

SEOUL APP 119.75
119.1
GIMPO TWR 118.1
118.05

SEOUL/Gimpo Intl(RKSS)
ILS or LOC RWY 14R
CAT II & III

Note : Approach under ICAO Flight Procedures.

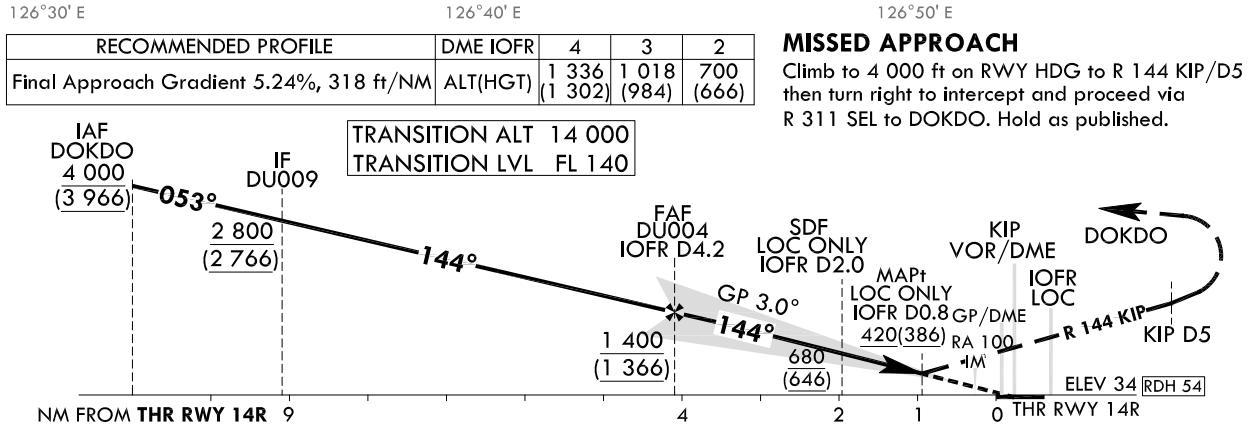
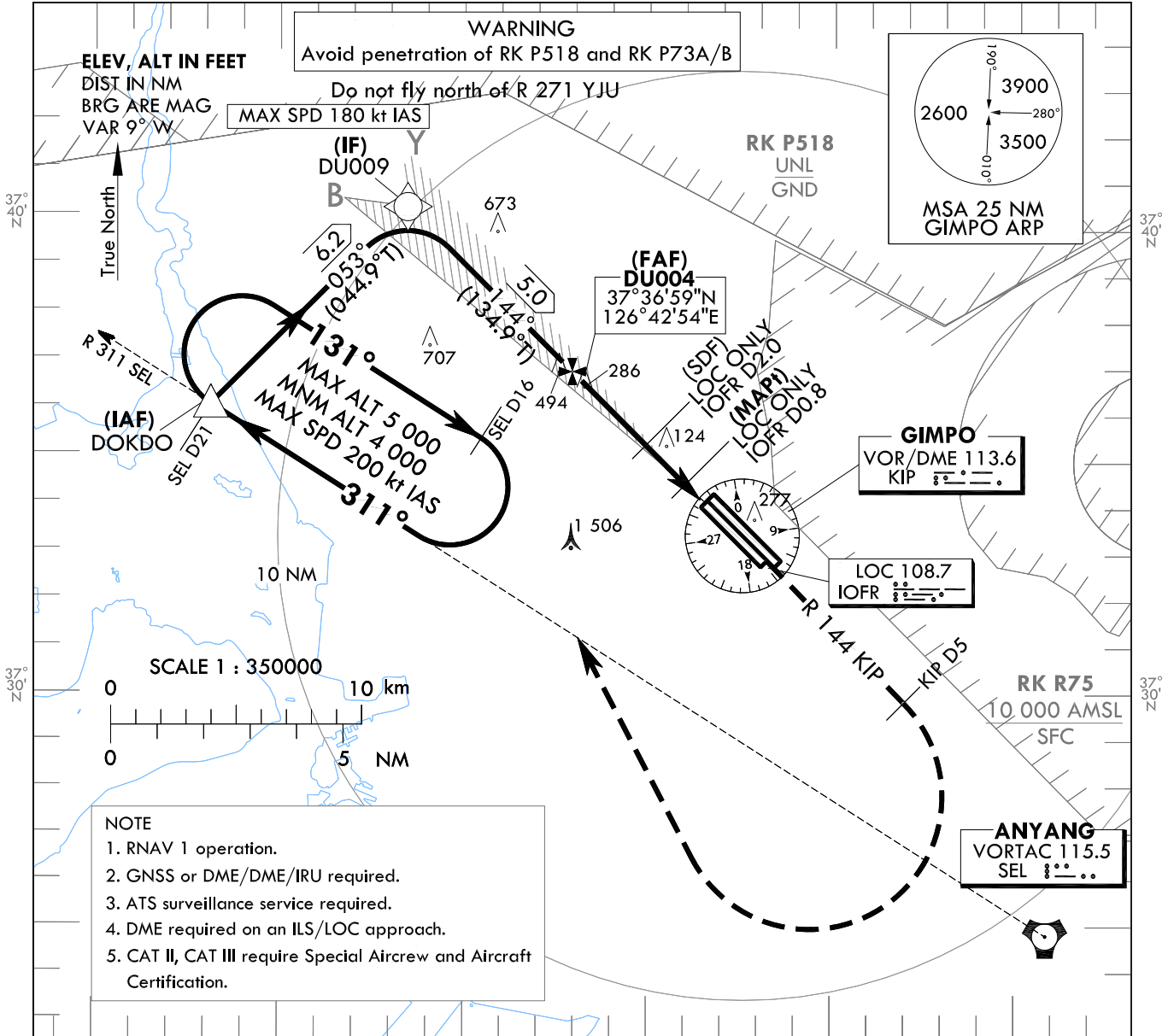

CATEGORY	DA(DH)/MDA(MDH)	RVR				NOTE	
		A	B	C	D		
Straight-in	CAT-I	FULL	234 (200)				1. Missed approach turn limited to 220 kt IAS maximum.
		ALS INOP	RVR 550 m, VIS 800 m				
	LOC	FULL	420 (386)				1) For CAT D aeroplane conducting an autoland. 2) Aeroplane use Fail-operational system.
		ALS INOP	1 100 m				
CAT II		134(100)		300 m		* Timing Not authorized for defining MAPt.	
CAT III		-		75 m ² /125 m		* Circling Not authorized.	

Change : Amended phrase for LOC category.

SEOUL/Gimpo Intl(RKSS)
ILS or LOC RWY 14R
CAT II & III

AERONAUTICAL DATA TABULATION

ILS/LOC Approach to RWY 14R from DOKDO		
Fix / Point		Coordinates
DOKDO(IAF)		37°36'17.1"N 126°33'07.1"E
DU009(IF)	BRG 53.48°/6.00 NM	37°40'31.8"N 126°38'26.2"E
DU004(FAF)	BRG 143.53°/4.20 NM IOFR	37°36'59.0"N 126°42'54.3"E
D2.0 IOFR (SDF LOC ONLY)	BRG 143.53°/2.00 NM IOFR	37°35'23.9"N 126°44'53.9"E
D0.8 IOFR (MAPt LOC ONLY)	BRG 143.53°/0.80 NM IOFR	37°34'32.9"N 126°45'58.1"E
THR RWY 14R		37°34'06.19"N 126°46'31.60"E
IOFR DME		37°34'01.9"N 126°46'44.2"E
KIP VOR/DME		37°33'27.1"N 126°47'31.3"E
D5 KIP	R 144 KIP/5.00 NM	37°29'50.7"N 126°51'52.7"E
DOKDO	R 311 SEL/21.00 NM	37°36'17.1"N 126°33'07.1"E

**INSTRUMENT
APPROACH
CHART - ICAO**

AERODROME ELEV 59 ft
HEIGHTS RELATED TO
THR RWY 14R - ELEV 34 ft

SEOUL APP 119.75
119.1
GIMPO TWR 118.1
118.05

**SEOUL/Gimpo Intl(RKSS)
RNP RWY 14R**

Note : Approach under ICAO Flight Procedures.

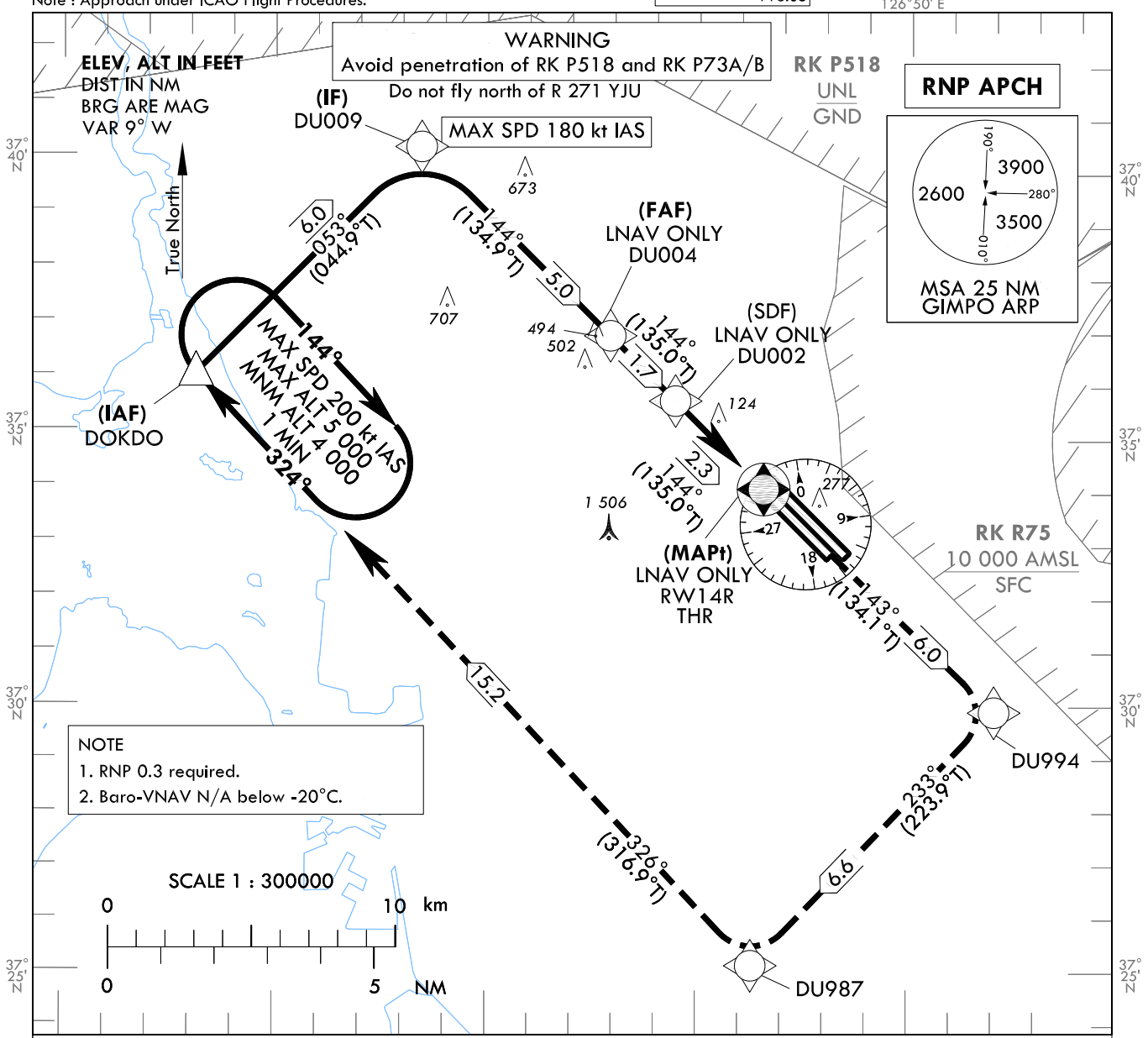

MISSED APPROACH

Climb to 4 000 ft. Track to DU994, DU987 and DOKDO. Hold as published.

NOTE

1. Missed approach turn limited to 220 kt IAS maximum.

TRANSITION ALT 14 000
TRANSITION LVL FL 140

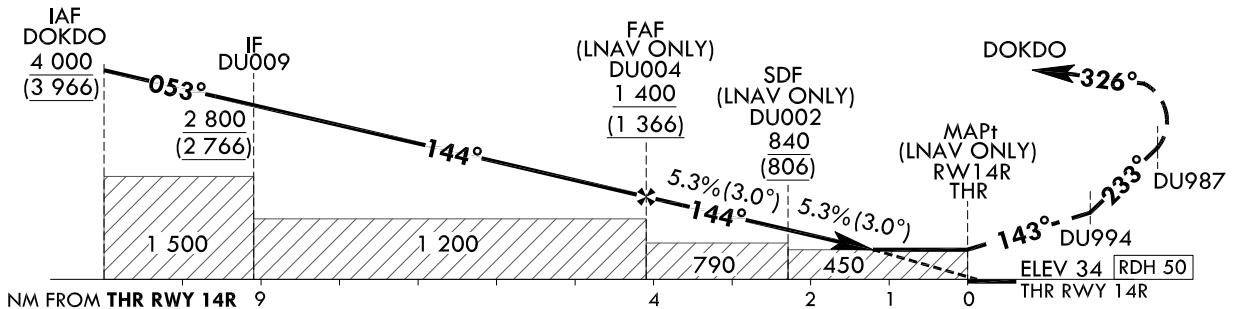

CATEGORY		MDA(H)/DA(H)	A	B	C	D	Knots						
LNAV	FULL	450 (416)		1 200 m			Rate of descent	V/V fpm	318	478	637	796	955
	ALS INOP			1 900 m									
LNAV/VNAV	FULL	450 (416)		1 200 m			* Timing Not authorized for defining MAPt. * Circling Not authorized.						
	ALS INOP			1 900 m									

Change : Page control.

AERONAUTICAL DATA TABULATION

Instrument Approach Procedure Coding Tables

RNP RWY 14R

Serial Number	Path Descriptor	Waypoint Identifier	Fly-over	Course/Track °M(°T)	Distance (NM)	Turn direction	Altitude (ft)	Speed (kt)	Coordinates	VPA/TCH	Navigation specification	Remarks
001	IF	DOKDO	-	-	-	-	+4 000	-	37°36'17.1"N 126°33'07.1"E	-	RNP APCH	IAF
002	TF	DU009	-	053 (044.9)	6.0	-	+2 800	-180	37°40'31.8"N 126°38'26.2"E	-	RNP APCH	IF
003	TF	DU004	-	144 (134.9)	5.0	-	+1 400	-	37°36'59.0"N 126°42'54.3"E	-	RNP APCH	FAF
004	TF	DU002	-	144 (135.0)	1.7	-	+840	-	37°35'45.6"N 126°44'26.6"E	-	RNP APCH	SDF
005	TF	RW14R	Y	144 (135.0)	2.3	-	+450	-	37°34'06.19"N 126°46'31.60"E	-3.01/50	RNP APCH	MAPt
006	TF	DU994	-	143 (134.1)	6.0	-	-	-	37°29'54.5"N 126°51'57.6"E	-	RNP APCH	-
007	TF	DU987	-	233 (223.9)	6.6	-	-	-220	37°25'09.3"N 126°46'13.6"E	-	RNP APCH	-
008	TF	DOKDO	Y	326 (316.9)	15.2	-	+4 000	-220	37°36'17.1"N 126°33'07.1"E	-	RNP APCH	-
009	HM	DOKDO	Y	324 (314.9)	-	R	-5 000 +4 000	-200	37°36'17.1"N 126°33'07.1"E	-	RNP APCH	1 min (Outbound timing)

**INSTRUMENT
APPROACH
CHART - ICAO**

AERODROME ELEV 59 ft
HEIGHTS RELATED TO
THR RWY 32L - ELEV 41 ft

SEOUL APP 119.75
119.1
GIMPO TWR 118.1
118.05

**SEOUL/Gimpo Intl(RKSS)
ILS or LOC RWY 32L**

Note : Approach under ICAO Flight Procedures.

126°50'E

127°10'E

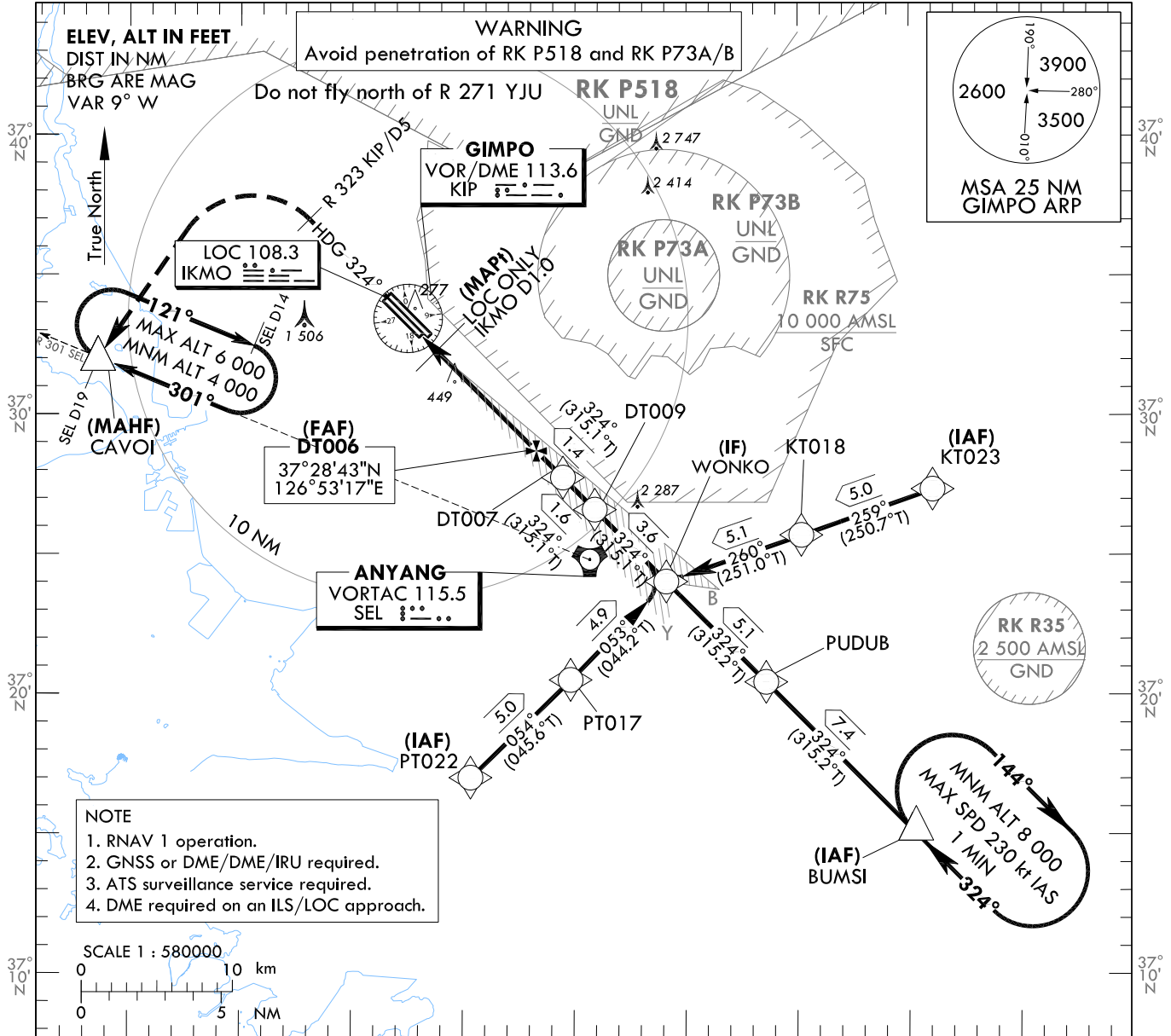

RECOMMENDED PROFILE		DME IKMO	6	5	4	3
Final Approach Gradient 5.24%, 318 ft/NM	ALT(HGT)		1 969 (1 926)	1 655 (1 614)	1 328 (1 287)	1 004 (963)

TRANSITION ALT 14 000
TRANSITION LVL FL 140

NOTE
1. Missed approach turn limited to 220 kt IAS maximum.

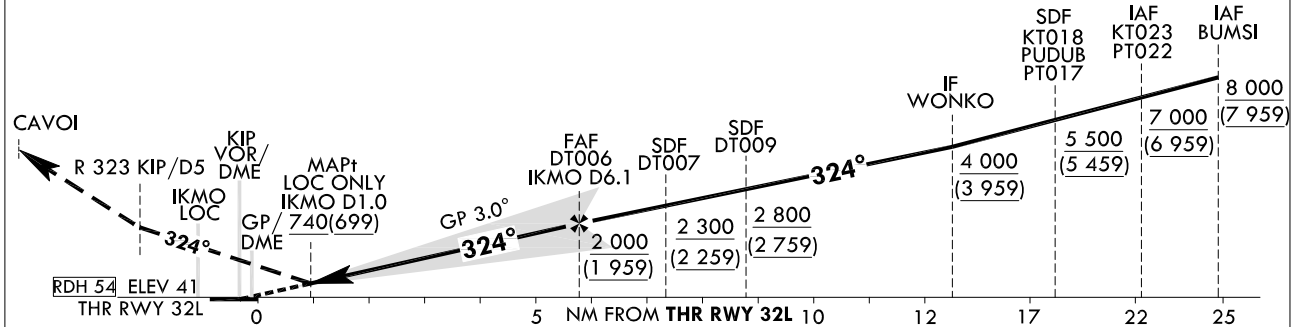

CATEGORY	DA(DH)/MDA(MDH)	MISSED APPROACH				
		A	B	C	D	
Straight-in	CAT-I	FULL	RVR 550 m, VIS 800 m			
		ALS INOP	1 200 m			
	LOC	FULL	2 500 m			
		ALS INOP	3 200 m			

After 500 ft, Climb on HDG 324° to R 323 KIP/D5. Continue climb to 4 000 ft. Turn left direct to CAVOI. Hold as published.
* Timing Not authorized for defining MAPt.
* Circling Not authorized.

Change : Amended phrase for LOC category.

SEOUL/Gimpo Intl(RKSS)
ILS or LOC RWY 32L

AERONAUTICAL DATA TABULATION

ILS/LOC Approach to RWY 32L from KT023 to WONKO(IF)		
Fix / Point		Coordinates
KT023(IAF)		37°27'20.9"N 127°11'04.4"E
KT018(SDF)	BRG 259.29°/5.00 NM	37°25'41.9"N 127°05'11.1"E
WONKO(IF)	BRG 259.60°/5.10 NM	37°24'02.0"N 126°59'08.0"E
ILS/LOC Approach to RWY 32L from BUMSI to WONKO(IF)		
Fix / Point		Coordinates
BUMSI(IAF)		37°15'10.2"N 127°10'09.6"E
PUDUB(SDF)	BRG 323.86°/7.42 NM	37°20'26.5"N 127°03'36.6"E
WONKO(IF)	BRG 323.79°/5.06 NM	37°24'02.0"N 126°59'08.0"E
ILS/LOC Approach to RWY 32L from PT022 to WONKO(IF)		
Fix / Point		Coordinates
PT022(IAF)		37°17'00.6"N 126°50'21.9"E
PT017(SDF)	BRG 54.22°/5.00 NM	37°20'30.7"N 126°54'50.7"E
WONKO(IF)	BRG 52.77°/4.90 NM	37°24'02.0"N 126°59'08.0"E
ILS/LOC Approach to RWY 32L from WONKO(IF) to MAHF		
Fix / Point		Coordinates
DT009(SDF)	BRG 323.72°/9.10 NM IKMO	37°26'36.1"N 126°55'55.6"E
DT007(SDF)	BRG 323.72°/7.50 NM IKMO	37°27'44.9"N 126°54'29.5"E
DT006(FAF)	BRG 323.72°/6.10 NM IKMO	37°28'42.9"N 126°53'17.0"E
D1.0 IKMO (MAPt LOC ONLY)	BRG 323.72°/1.00 NM IKMO	37°32'17.6"N 126°48'48.0"E
THR RWY 32L		37°32'52.83"N 126°48'03.71"E
IKMO DME		37°32'57.4"N 126°47'51.3"E
KIP VOR/DME		37°33'27.1"N 126°47'31.3"E
Climb to 500 ft	HDG 324	-
D5 KIP	R 323 KIP/5.00 NM	37°36'59.7"N 126°43'04.6"E
CAVOI	BRG 223.11°/19.00 NM SEL	37°32'02.0"N 126°33'37.0"E

**INSTRUMENT
APPROACH
CHART - ICAO**

AERODROME ELEV 59 ft
HEIGHTS RELATED TO
THR RWY 32L - ELEV 41 ft

SEOUL APP 119.75
119.1
GIMPO TWR 118.2
118.8

SEOUL/Gimpo Intl(RKSS)
RNP RWY 32L

Note : Approach under ICAO Flight Procedures.

126°50'E

127°10'E

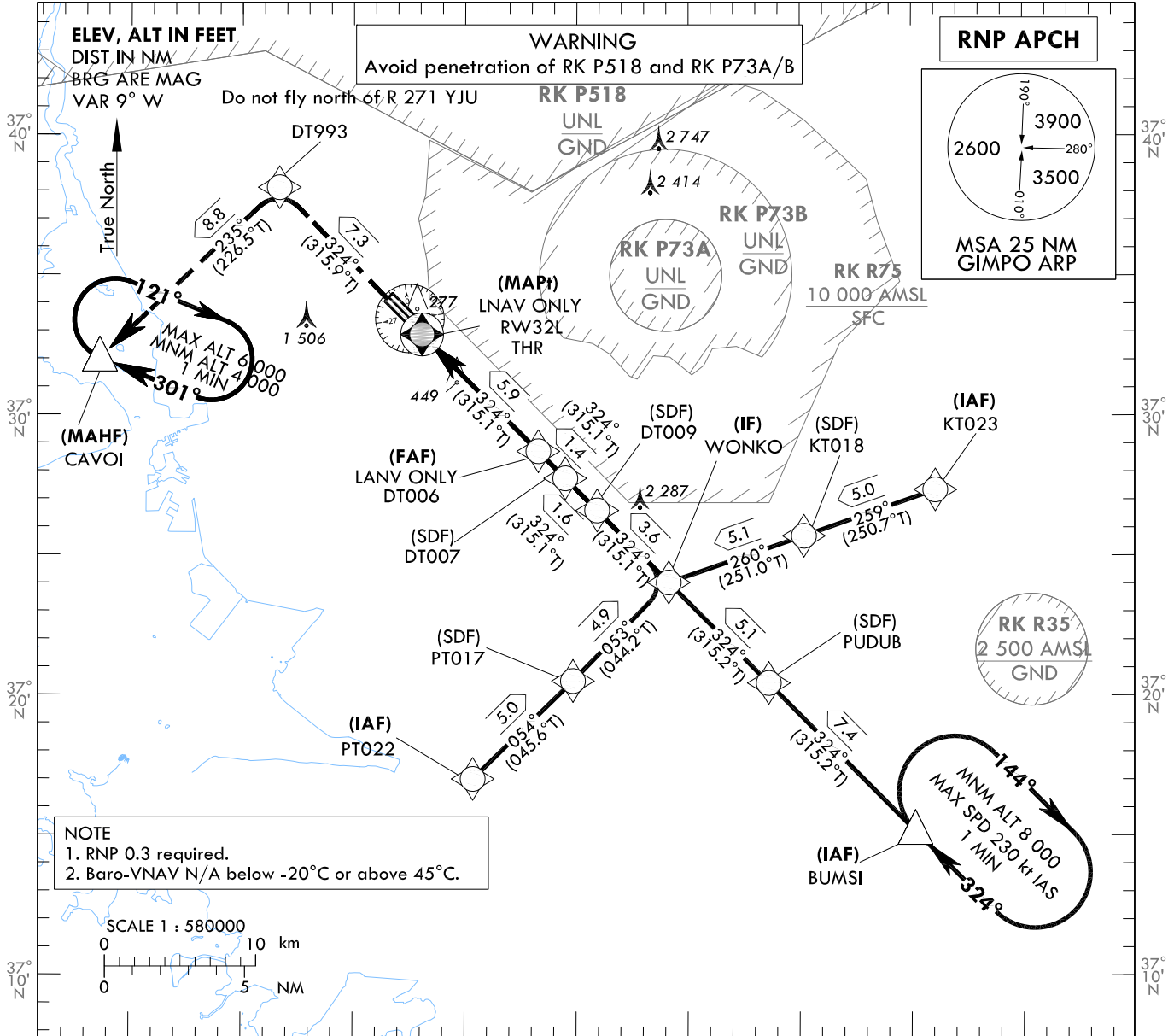

NOTE
1. RNP 0.3 required.
2. Baro-VNAV N/A below -20°C or above 45°C.

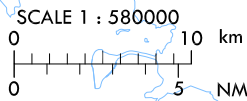

MISSED APPROACH

Climb to 4 000 ft. Track to DT993 and CAVOI.
Hold as published.

TRANSITION ALT 14 000
TRANSITION LVL FL 140

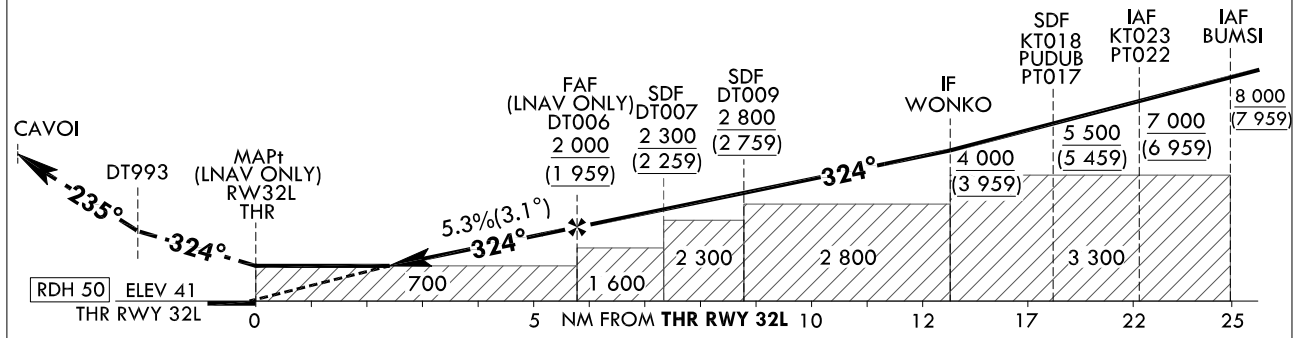

CATEGORY	MDA(H)/DA(H)	A				B				C				D				Knots	60	90	120	150	180
		Rate of descent	V/V fpm	325	487	649	812	974															
STA	LNAV	FULL	700 (659)	2 300 m				3 000 m															
		ALS INOP		3 000 m																			
	LNAV/VNAV	FULL	610 (569)	1 900 m																			
		ALS INOP		2 600 m																			

Change : Page control.

SEOUL/Gimpo Intl(RKSS)
RNP RWY 32L

AERONAUTICAL DATA TABULATION

Instrument Approach Procedure Coding Tables												
RNP RWY 32L - via KT023 to WONKO(IF)												
Serial Number	Path Descriptor	Waypoint Identifier	Fly-over	Course/Track over	Distance (NM)	Turn direction	Altitude (ft)	Speed (kt)	Coordinates	VPA/RDH	Navigation specification	Remarks
001	IF	KT023	-	-	-	-	+7 000	-	37°27'20.9"N 127°11'04.4"E	-	RNP APCH	IAF
002	TF	KT018	-	259 (250.7)	5.0	-	+5 500	-	37°25'41.9"N 127°05'11.1"E	-	RNP APCH	SDF
003	TF	WONKO	-	260 (251.0)	5.1	-	+4 000	-	37°24'02.0"N 126°59'08.0"E	-	RNP APCH	IF
RNP RWY 32L - via BUMSI to WONKO(IF)												
Serial Number	Path Descriptor	Waypoint Identifier	Fly-over	Course/Track over	Distance (NM)	Turn direction	Altitude (ft)	Speed (kt)	Coordinates	VPA/RDH	Navigation specification	Remarks
001	IF	BUMSI	-	-	-	-	+8 000	-	37°15'10.2"N 127°10'09.6"E	-	RNP APCH	IAF
002	TF	PUDU8	-	324 (315.2)	7.4	-	+5 500	-	37°20'26.5"N 127°03'36.6"E	-	RNP APCH	SDF
003	TF	WONKO	-	324 (315.2)	5.1	-	+4 000	-	37°24'02.0"N 126°59'08.0"E	-	RNP APCH	IF
RNP RWY 32L - via PT022 to WONKO(IF)												
Serial Number	Path Descriptor	Waypoint Identifier	Fly-over	Course/Track over	Distance (NM)	Turn direction	Altitude (ft)	Speed (kt)	Coordinates	VPA/RDH	Navigation specification	Remarks
001	IF	PT022	-	-	-	-	+7 000	-	37°17'00.6"N 126°50'21.9"E	-	RNP APCH	IAF
002	TF	PT017	-	054 (045.6)	5.0	-	+5 500	-	37°20'30.7"N 126°54'50.7"E	-	RNP APCH	SDF
003	TF	WONKO	-	053 (044.2)	4.9	-	+4 000	-	37°24'02.0"N 126°59'08.0"E	-	RNP APCH	IF
RNP RWY 32L - via WONKO(IF) to MAHF												
Serial Number	Path Descriptor	Waypoint Identifier	Fly-over	Course/Track over	Distance (NM)	Turn direction	Altitude (ft)	Speed (kt)	Coordinates	VPA/RDH	Navigation specification	Remarks
003	TF	WONKO	-	-	-	-	+4 000	-	37°24'02.0"N 126°59'08.0"E	-	RNP APCH	IF
004	TF	DT009	-	324 (315.1)	3.6	-	+2 800	-	37°26'36.1"N 126°55'55.6"E	-	RNP APCH	SDF
005	TF	DT007	-	324 (315.1)	1.6	-	+2 300	-	37°27'44.9"N 126°54'29.5"E	-	RNP APCH	SDF
006	TF	DT006	-	324 (315.1)	1.4	-	+2 000	-	37°28'42.9"N 126°53'17.0"E	-	RNP APCH	FAF
007	TF	RW32L	Y	324 (315.1)	5.9	-	+700	-	37°32'52.83"N 126°48'03.71"E	-3.06/50	RNP APCH	MAPt
008	TF	DT993	-	324 (315.9)	7.3	-	-	-	37°38'07.5"N 126°41'39.6"E	-	RNP APCH	-
009	TF	CAVOI	Y	235 (226.5)	8.8	-	+4 000	-	37°32'02.0"N 126°33'37.0"E	-	RNP APCH	-
HOLDING PROCEDURE												
Holding Identification	Path Descriptor	Waypoint Identifier	Fly-over	Course/Track over	Time (min)	Turn direction	Altitude (ft)	Speed (kt)	Coordinates	VPA/RDH	Navigation specification	Remarks
RNP RWY 32L	HM	BUMSI	Y	324 (315.2)	1	R	+8 000	-230	37°15'10.2"N 127°10'09.6"E	-	RNAV 1	-
	HM	CAVOI	Y	301 (292.2)	1	R	-6 000 +4 000	-	37°32'02.0"N 126°33'37.0"E	-	RNAV 1	-

Change : Page control.

SEOUL/Gimpo Intl(RKSS)
VOR RWY 32L

AERONAUTICAL DATA TABULATION

VOR Approach to RWY 32L from BUMSI		
Fix / Point		Coordinates
BUMSI(IAF)		37°15'10.2"N 127°10'09.6"E
D20 KIP(SDF)	BRG 320.65°/5.68 NM	37°19'00.4"N 127°04'54.7"E
D18 KIP(SDF)	BRG 324.48°/18.00 NM KIP	37°20'27.2"N 127°03'10.7"E
D13.2 KIP(IF)	BRG 324.48°/13.20 NM KIP	37°23'55.4"N 126°59'00.7"E
D9.6 KIP(SDF)	BRG 324.48°/9.60 NM KIP	37°26'31.4"N 126°55'52.9"E
D6.6 KIP(FAF)	BRG 324.48°/6.60 NM KIP	37°28'41.4"N 126°53'16.3"E
D3.0 KIP(SDF)	BRG 324.48°/3.00 NM KIP	37°31'17.3"N 126°50'08.2"E
D1.3 KIP(MAPt)	BRG 324.48°/1.30 NM KIP	37°32'30.8"N 126°48'39.2"E
THR RWY 32L	Final approach descent angle 2.98°(FAF - SDF)/3.16°(SDF - THR)	37°32'52.83"N 126°48'03.71"E
KIP VOR/DME		37°33'27.1"N 126°47'31.3"E
D5 KIP	R 323 KIP/5.00 NM	37°36'59.7"N 126°43'04.6"E
CAVOI	BRG 223.11°/19.00 NM SEL	37°32'02.0"N 126°33'37.0"E

Change : Page control.

**INSTRUMENT
APPROACH
CHART - ICAO**

AERODROME ELEV 59 ft
HEIGHTS RELATED TO
THR RWY 32R - ELEV 42 ft

SEOUL APP 119.75
119.1
GIMPO TWR 118.1
118.05

**SEOUL/Gimpo Intl(RKSS)
ILS or LOC RWY 32R**

Note : Approach under ICAO Flight Procedures.

126°50'E

127°10'E

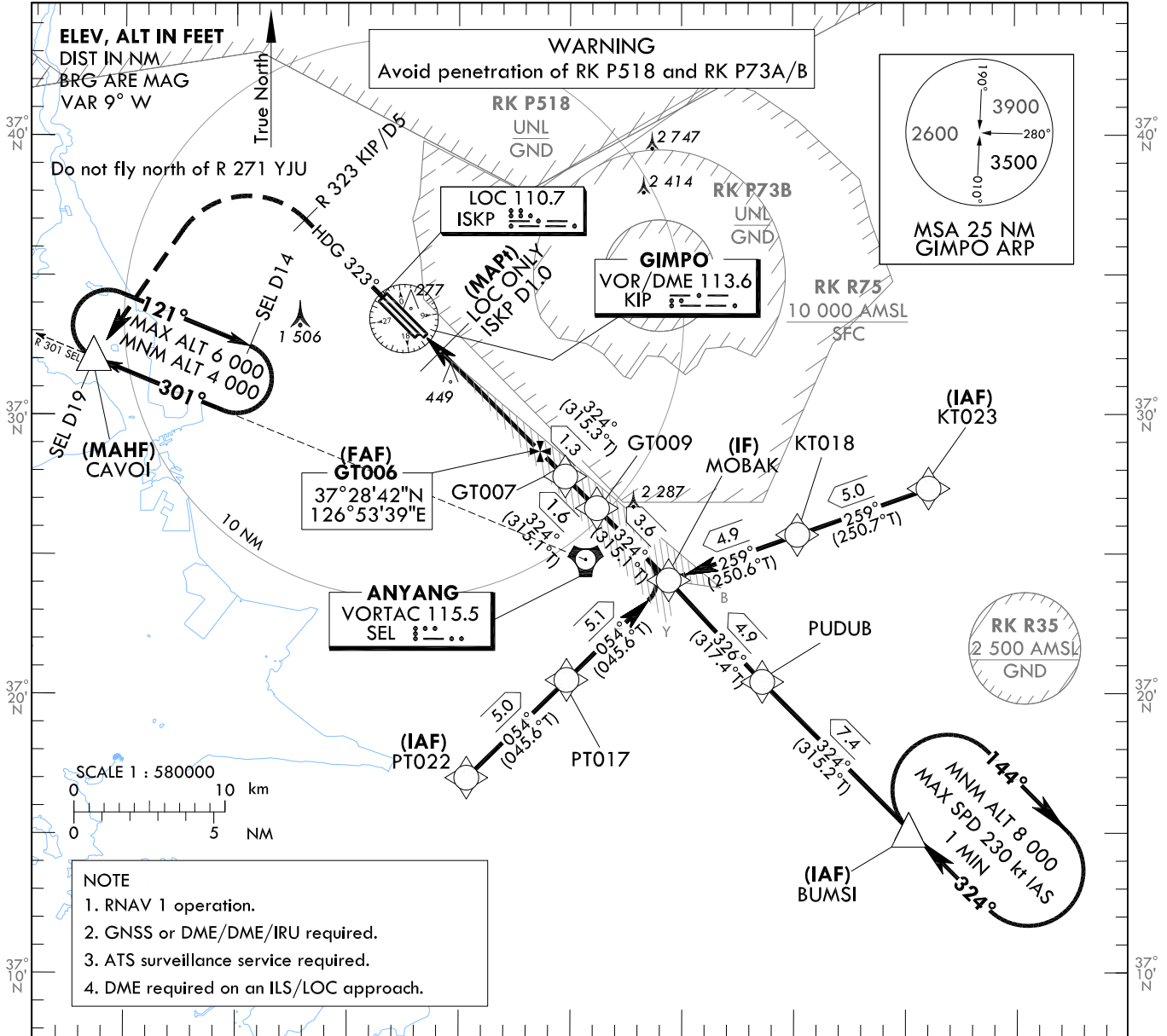

NOTE
1. RNAV 1 operation.
2. GNSS or DME/DME/IRU required.
3. ATS surveillance service required.
4. DME required on an ILS/LOC approach.

RECOMMENDED PROFILE	DME ISKP	6	5	4	3	2
Final Approach Gradient 5.24%, 318 ft/NM	ALT(HGT)	1 968 (1 926)	1 656 (1 614)	1 330 (1 288)	1 005 (963)	682 (640)

TRANSITION ALT 14 000
TRANSITION LVL FL 140

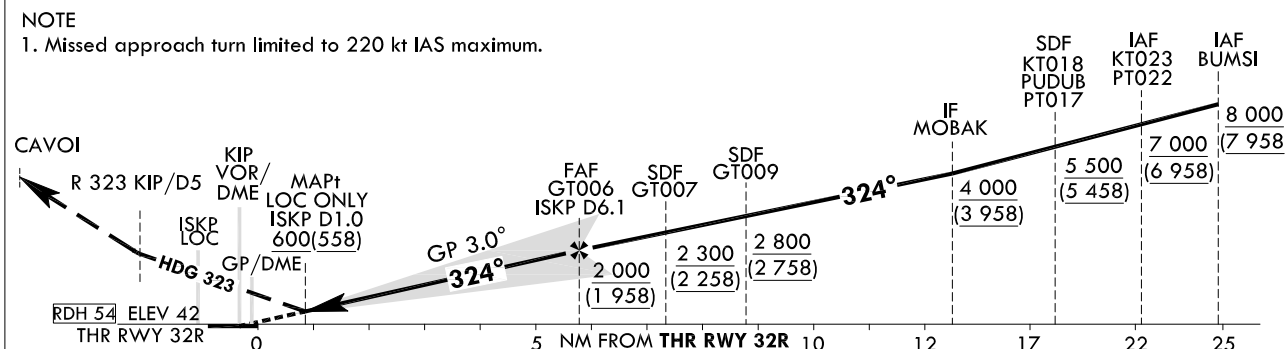

CATEGORY	DA(DH)/MDA(MDH)	A				MISSED APPROACH
		A	B	C	D	
Straight-in	CAT-I	FULL	RVR 550 m, VIS 800 m			After 500 ft, Climb on HDG 323° to R 323 KIP/D5. Continue climb to 4 000 ft. Turn left direct to CAVOI. Hold as published. * Timing Not authorized for defining MAPt. * Circling Not authorized.
		ALS INOP	1 200 m			
	LOC	FULL	1 800 m			
		ALS INOP	2 500 m			

Change : Amended phrase for LOC category.

SEOUL/Gimpo Intl(RKSS)
ILS or LOC RWY 32R

AERONAUTICAL DATA TABULATION

ILS/LOC Approach to RWY 32R from KT023 to MOBAK(IF)		
Fix / Point		Coordinates
KT023(IAF)		37°27'20.9"N 127°11'04.4"E
KT018(SDF)	BRG 259.29°/5.00 NM	37°25'41.9"N 127°05'11.1"E
MOBAK(IF)	BRG 259.23°/4.87 NM	37°24'04.7"N 126°59'25.2"E
ILS/LOC Approach to RWY 32R from BUMSI to MOBAK(IF)		
Fix / Point		Coordinates
BUMSI(IAF)		37°15'10.2"N 127°10'09.6"E
PUDUB(SDF)	BRG 323.86°/7.42 NM	37°20'26.5"N 127°03'36.6"E
MOBAK(IF)	BRG 326.03°/4.93 NM	37°24'04.7"N 126°59'25.2"E
ILS/LOC Approach to RWY 32R from PT022 to MOBAK(IF)		
Fix / Point		Coordinates
PT022(IAF)		37°17'00.6"N 126°50'21.9"E
PT017(SDF)	BRG 54.22°/5.00 NM	37°20'30.7"N 126°54'50.7"E
MOBAK(IF)	BRG 54.26°/5.10 NM	37°24'04.7"N 126°59'25.2"E
ILS/LOC Approach to RWY 32R from MOBAK(IF) to MAHF		
Fix / Point		Coordinates
GT009(SDF)	BRG 323.75°/9.00 NM ISKP	37°26'39.3"N 126°56'12.2"E
GT007(SDF)	BRG 323.75°/7.40 NM ISKP	37°27'47.4"N 126°54'47.0"E
GT006(FAF)	BRG 323.90°/6.10 NM ISKP	37°28'42.2"N 126°53'38.9"E
D1.0 ISKP (MAPt LOC ONLY)	BRG 323.90°/1.00 NM ISKP	37°32'16.7"N 126°49'09.7"E
THR RWY 32R		37°32'51.89"N 126°48'25.58"E
ISKP DME		37°32'56.3"N 126°48'12.9"E
KIP VOR/DME		37°33'27.1"N 126°47'31.3"E
Climb to 500 ft	HDG 323	-
D5 KIP	R 323 KIP/5.00 NM	37°36'59.7"N 126°43'04.6"E
CAVOI	BRG 222.76°/19.00 NM SEL	37°32'02.0"N 126°33'37.0"E

**INSTRUMENT
APPROACH
CHART - ICAO**

AERODROME ELEV 59 ft
HEIGHTS RELATED TO
THR RWY 32R - ELEV 42 ft

SEOUL APP 119.75
119.1
GIMPO TWR 118.1
118.05

**SEOUL/Gimpo Intl(RKSS)
RNP RWY 32R**

Note : Approach under ICAO Flight Procedures.

126°50'E

127°10'E

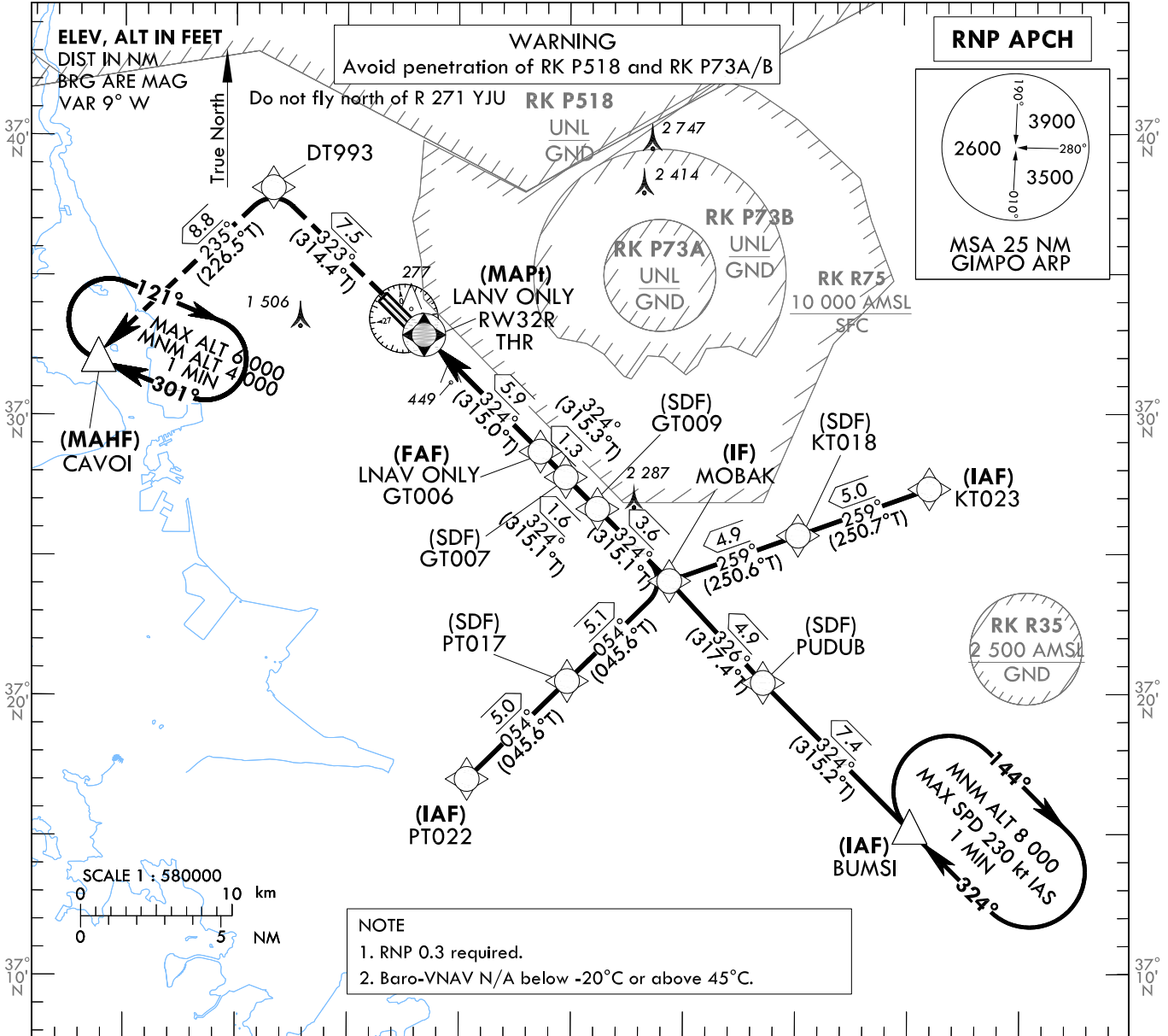

MISSED APPROACH

Climb to 4 000 ft. Track to DT993 and CAVOI. Hold as published.

TRANSITION ALT 14 000
TRANSITION LVL FL 140

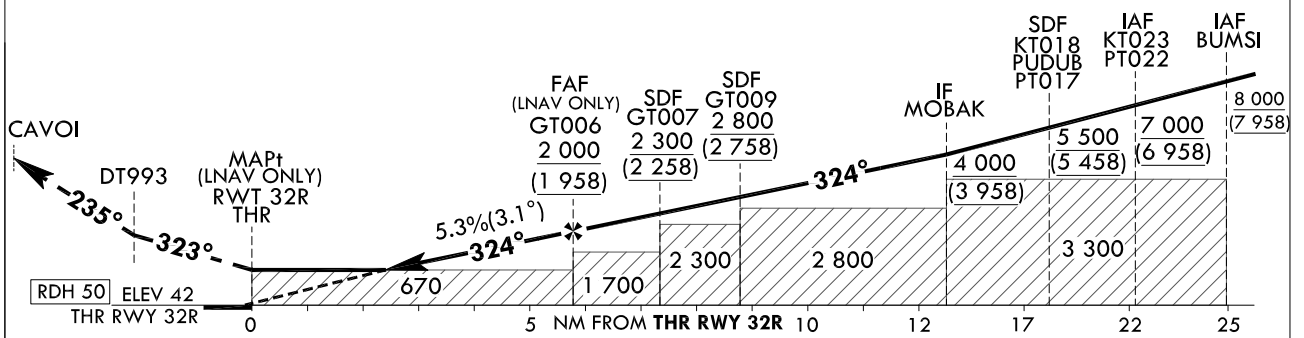

CATEGORY		MDA(H)/DA(H)	A	B	C	D	Knots						
STA	LNAV	FULL	670	2 200 m			Rate of descent	V/V fpm	325	487	649	812	974
		ALS INOP	(628)	2 900 m									
	LNAV/VNAV	FULL	600	1 800 m			* Timing Not authorized for defining MAPt. * Circling Not authorized.						
		ALS INOP	(558)	2 500 m									

Change : Page control.

AERONAUTICAL DATA TABULATION

Instrument Approach Procedure Coding Tables

RNP RWY 32R - via KT023 to MOBAK(IF)

Serial Number	Path Descriptor	Waypoint Identifier	Fly-over	Course/Track °M(°T)	Distance (NM)	Turn direction	Altitude (ft)	Speed (kt)	Coordinates	VPA/RDH	Navigation specification	Remarks
001	IF	KT023	-	-	-	-	+7 000	-	37°27'20.9"N 127°11'04.4"E	-	RNP APCH	IAF
002	TF	KT018	-	259 (250.7)	5.0	-	+5 500	-	37°25'41.9"N 127°05'11.1"E	-	RNP APCH	SDF
003	TF	MOBAK	-	259 (250.6)	4.9	-	+4 000	-	37°24'04.7"N 126°59'25.2"E	-	RNP APCH	IF

RNP RWY 32R - via BUMSI to MOBAK(IF)

Serial Number	Path Descriptor	Waypoint Identifier	Fly-over	Course/Track °M(°T)	Distance (NM)	Turn direction	Altitude (ft)	Speed (kt)	Coordinates	VPA/RDH	Navigation specification	Remarks
001	IF	BUMSI	-	-	-	-	+8 000	-	37°15'10.2"N 127°10'09.6"E	-	RNP APCH	IAF
002	TF	PUDUB	-	324 (315.2)	7.4	-	+5 500	-	37°20'26.5"N 127°03'36.6"E	-	RNP APCH	SDF
003	TF	MOBAK	-	326 (317.4)	4.9	-	+4 000	-	37°24'04.7"N 126°59'25.2"E	-	RNP APCH	IF

RNP RWY 32R - via PT022 to MOBAK(IF)

Serial Number	Path Descriptor	Waypoint Identifier	Fly-over	Course/Track °M(°T)	Distance (NM)	Turn direction	Altitude (ft)	Speed (kt)	Coordinates	VPA/RDH	Navigation specification	Remarks
001	IF	PT022	-	-	-	-	+7 000	-	37°17'00.6"N 126°50'21.9"E	-	RNP APCH	IAF
002	TF	PT017	-	054 (045.6)	5.0	-	+5 500	-	37°20'30.7"N 126°54'50.7"E	-	RNP APCH	SDF
003	TF	MOBAK	-	054 (045.6)	5.1	-	+4 000	-	37°24'04.7"N 126°59'25.2"E	-	RNP APCH	IF

RNP RWY 32R - via MOBAK(IF) to MAHF

Serial Number	Path Descriptor	Waypoint Identifier	Fly-over	Course/Track °M(°T)	Distance (NM)	Turn direction	Altitude (ft)	Speed (kt)	Coordinates	VPA/RDH	Navigation specification	Remarks
003	TF	MOBAK	-	-	-	-	+4 000	-	37°24'04.7"N 126°59'25.2"E	-	RNP APCH	IF
004	TF	GT009	-	324 (315.1)	3.6	-	+2 800	-	37°26'39.3"N 126°56'12.2"E	-	RNP APCH	SDF
005	TF	GT007	-	324 (315.1)	1.6	-	+2 300	-	37°27'47.4"N 126°54'47.0"E	-	RNP APCH	SDF
006	TF	GT006	-	324 (315.3)	1.3	-	+2 000	-	37°28'42.2"N 126°53'38.9"E	-	RNP APCH	FAF
007	TF	RW32R	Y	324 (315.0)	5.9	-	+670	-	37°32'51.89"N 126°48'25.58"E	-3.06/50	RNP APCH	MAPI
008	TF	DT993	-	323 (314.4)	7.5	-	-	-	37°38'07.5"N 126°41'39.6"E	-	RNP APCH	-
009	TF	CAVOI	Y	235 (226.5)	8.8	-	+4 000	-	37°32'02.0"N 126°33'37.0"E	-	RNP APCH	-

HOLDING PROCEDURE

Holding Identification	Path Descriptor	Waypoint Identifier	Fly-over	Course/Track °M(°T)	Distance (NM)	Time (min)	Turn direction	Altitude (ft)	Speed (kt)	Coordinates	VPA/RDH	Navigation specification	Remarks
RNP RWY 32R	HM	BUMSI	Y	324 (315.2)	1	R	+8 000	-230	-	37°15'10.2"N 127°10'09.6"E	-	RNAV 1	-
	HM	CAVOI	Y	301 (292.2)	1	R	+6 000 +4 000	-	-	37°32'02.0"N 126°33'37.0"E	-	RNAV 1	-

**INSTRUMENT
APPROACH
CHART - ICAO**

AERODROME ELEV 59 ft
HEIGHTS RELATED TO
THR RWY 32R - ELEV 42 ft

SEOUL APP 119.75
119.1
GIMPO TWR 118.1
118.05

**SEOUL/Gimpo Intl(RKSS)
VOR RWY 32R**

Note : Approach under ICAO Flight Procedures. 126°50'E

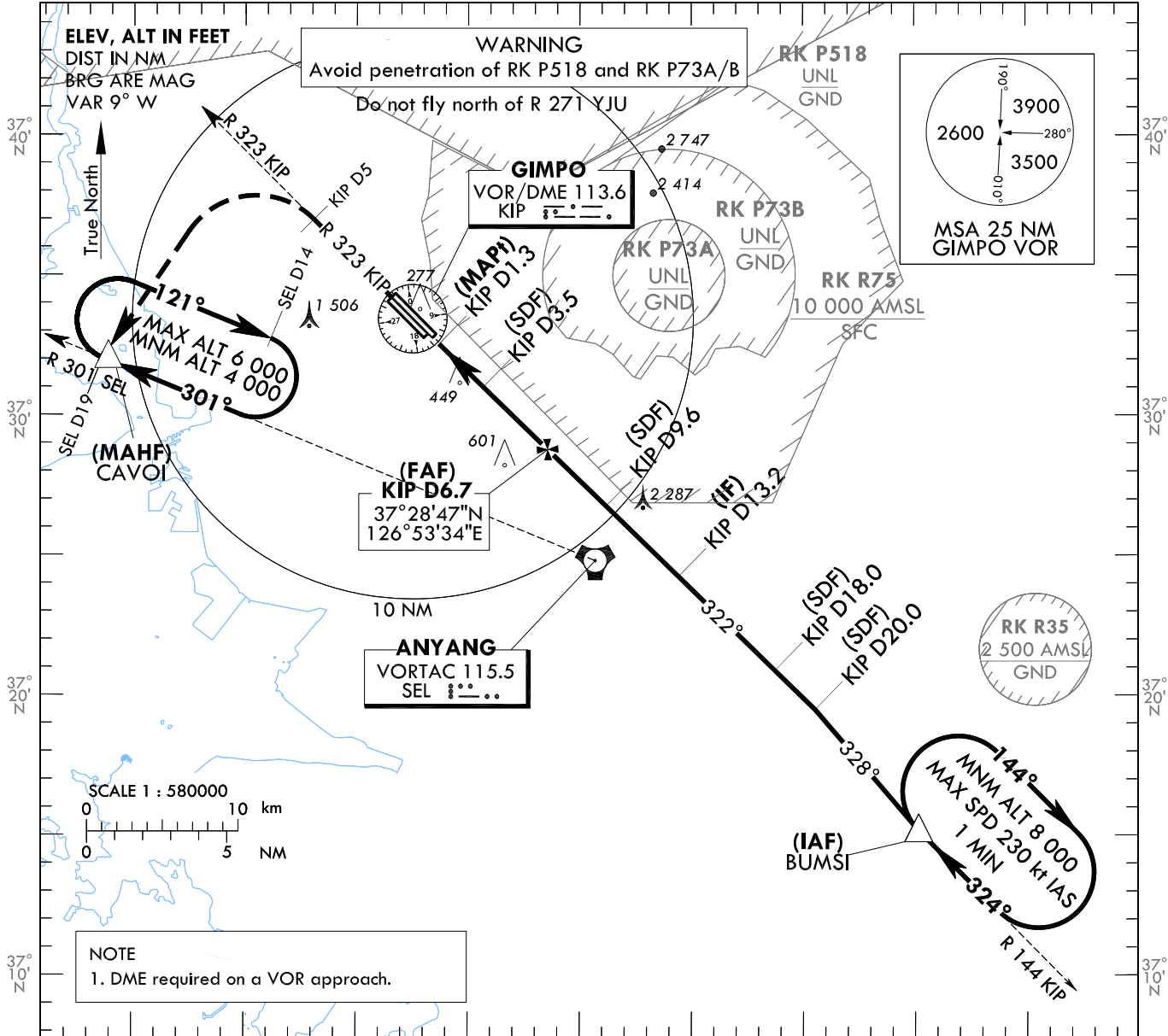

RECOMMENDED PROFILE		DME KIP	6	5	4	3
Final Gradient 5.2%(318.8 ft/NM) to SDF, 5.7%(345.5 ft/NM) to THR		ALT(HGT)	1 779 (1 737)	1 460 (1 418)	1 141 (1 399)	809 (767)

MISSED APPROACH
Climb to 4 000 ft on R 323 KIP to 5 DME then turn left direct to CAVOI.
Hold as published.

TRANSITION ALT 14 000
TRANSITION LVL FL 140

NOTE
1. Missed approach turn limited to 220 kt IAS maximum.

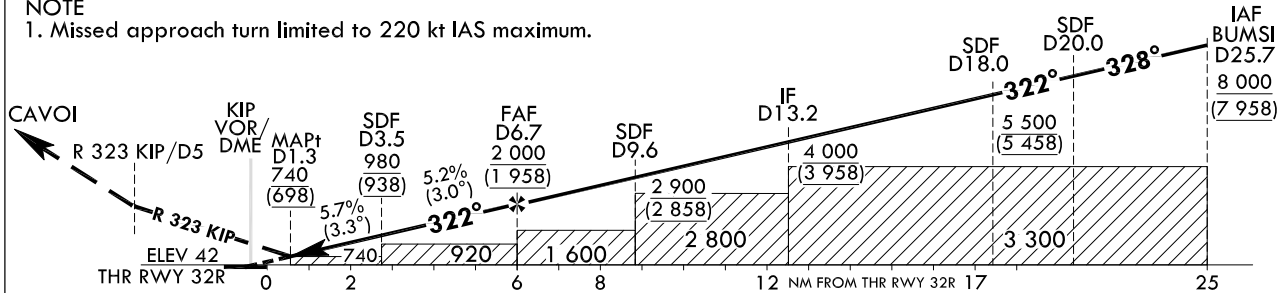

CATEGORY		MDA(MDH)	A	B	C	D	Knots						
Straight-in	FULL	740 (698)	2 500 m				Rate of descent	V/V fpm	331	486	661	827	992
	ALS INOP		3 200 m					* Timing Not authorized for defining MAPt. * Circling Not authorized.					

Change : Page control.

SEOUL/Gimpo Intl(RKSS)
VOR RWY 32R

AERONAUTICAL DATA TABULATION

VOR Approach to RWY 32R from BUMSI		
Fix / Point		Coordinates
BUMSI(IAF)		37°15'10.2"N 127°10'09.6"E
D20 KIP(SDF)	BRG 327.70°/5.69 NM	37°19'29.9"N 127°05'32.0"E
D18 KIP(SDF)	BRG 322.48°/18.00 NM KIP	37°20'53.8"N 127°03'44.2"E
D13.2 KIP(IF)	BRG 322.48°/13.20 NM KIP	37°24'15.2"N 126°59'25.7"E
D9.6 KIP(SDF)	BRG 322.48°/9.60 NM KIP	37°26'45.9"N 126°56'11.2"E
D6.7 KIP(FAF)	BRG 322.48°/6.70 NM KIP	37°28'47.0"N 126°53'34.1"E
D3.5 KIP(SDF)	BRG 322.48°/3.50 NM KIP	37°31'00.8"N 126°50'40.9"E
D1.3 KIP(MAPt)	BRG 322.48°/1.30 NM KIP	37°32'32.8"N 126°48'41.7"E
THR RWY 32R	Final approach descent angle 3.00°(FAF - SDF)/3.25°(SDF - THR)	37°32'51.89"N 126°48'25.58"E
KIP VOR/DME		37°33'27.1"N 126°47'31.3"E
D5 KIP	R 323 KIP/5.00 NM	37°36'59.7"N 126°43'04.6"E
CAVOI	BRG 223.11°/19.00 NM SEL	37°32'02.0"N 126°33'37.0"E

Change : Page control.